



Vebko Co.



CE

Relay Tester AMT105

List of Contents

- ▶ History of Vebko Amirkabir
- ▶ Capabilities of AMT105 Relay Tester
- ▶ Brief List of Specifications
- ▶ List of Clients
- ▶ Certificates , Testimonials & Vendor List of Petroleum Ministry of Iran
- ▶ Contact Information

History of Vebko Amirkabir

Vebko is a science-based company, established in 2014 by order of the science and technology vice-president of Iran to manufacture national relay tester device under the supervision of Amirkabir university of technology. The first industrial product of this company entered the market in 2015 and within three years more than 300 relay tester devices were sold to important industrial centers of electricity , oil and gas as well as some universities.

AMT105 is a universal solution to testing all types of relays and protective equipment, circuit breakers, thermal cables and sensors as well as power, current, voltage and capacitor-voltage transformers. Because of these features, this device is capable of testing different kinds of relays and protective equipment :

Six 32A current (64A in three-phase mode, 128A in single-phase mode), four 150V voltage sources (450 V in single-phase mode), current and voltage combination cable, 8 analog binary inputs, 2 DC analog current and voltage inputs with high accuracy, 4 binary outputs, DC voltage Source (212 V)

Certificates & Testimonials

Certified by

- ▶ Iran Power Grid Management
- ▶ Tavanir Co.
- ▶ Niroom Research institute
- ▶ IMIDRO
- ▶ Thermal Power Plants Holding
- ▶ Sanjesh koosha



Certificate related to calibration and certification of Vebko Community

CE Certificate obtained from IMQ

AVL List

- ▶ Khorasan Steel Complex Co.
- ▶ Khozestan Oxin Steel Co.
- ▶ Hormozgan Steel Co.
- ▶ Marun Petrochemical Co.
- ▶ Khouzestan Steel Co.
- ▶ Pars Oil and Gas Co.
- ▶ Pasdargad Oil Co.
- ▶ Qom Combined Cycle Co.
- ▶ Petroleum Vendor List Iranian
- ▶ National Iranian Copper Industry Co.
- ▶ Provider Members of Niroom Research Institute
- ▶ Zarand Iranian Steel Co.
- ▶ Khorasan Petrochemical Co.
- ▶ Bandar Abbas Oil Refining Co.



Capabilities of AMT105

Software Specifications

1. Capable of testing a wide range of static, electromechanical & numerical relays
2. Capable of reading, editing & creating all XRio & Rio files
3. Capable of transient testing
4. Capable of point-to-point or end-to-end testing
5. Built-in GPS & Wi-Fi Modules
6. Automatically performing tests
7. Comprehensive report of tests
8. Capable of automatically filling out the test sheets of different companies
9. Compatible with Windows XP, 8, 10, 11
10. Supporting Android & iOS apps
11. Autosave, redo & undo options
12. Manual HTML file in Persian , English , Germany , Spanish
13. Using bootloader technology to update firmware
14. A host of training videos

Capable of testing power transformers

1. Winding resistance
2. No-Load current
3. Magnetic balance
4. Tap Changer continuity
5. Ratio (TTR)
6. Vector group
7. Demagnetizing
8. Leakage reactance

Capable of testing current transformers (CT)

1. Excitation (Saturation)
2. Hysteresis curve
3. Ratio using current or voltage
4. polarity using current or voltage
5. Phase error
6. Winding resistance
7. Secondary burden

Capable of testing transducers & Meters

1. Highly precise in testing transducers & meters
2. Equipped with a pulse counter to automatically read energy

Capable of testing VT/CVT

1. Ratio & Polarity
2. Winding resistance
3. Short Circuit impedance
4. Excitation

Capable of testing circuit breakers (CB) & sectioners

1. Testing the opening & closing time
2. Contact resistance
3. Minimum voltage to operate CB test

Relay Tester AMT105



Tester Hardware Features

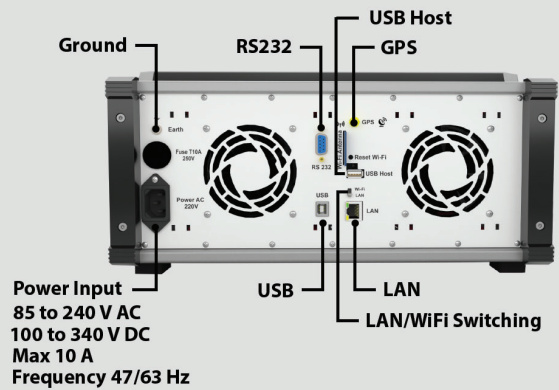
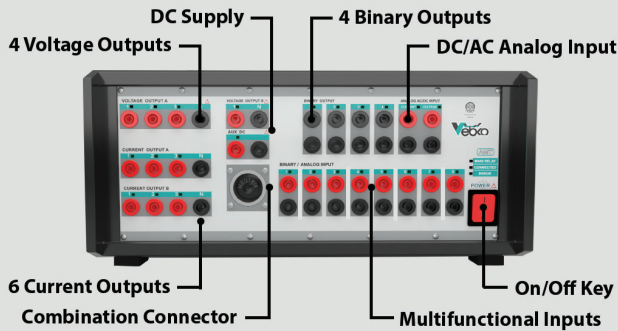

A summary of electrical & physical characteristics of the device

Binary Outputs , Relays

Type	Potential-free relay contacts, software controlled
Number	4
Break Capacity AC	Vmax: 250 VAC / Imax: 10 A / Pmax: 1250 VA
Break Capacity DC	Vmax: 30 VDC / Imax: 10 A / Pmax: 150W
LED	Yes

AC/DC Voltage Measuring Input

Measuring Range	0 ... ± 200 mV
Accuracy	50 µV
Resolution	6 µV
Input Impedance	10 KΩ
LED	Yes

AC/DC Current Measuring Input

Measuring Range	0 ... ± 500 mA
Accuracy	50 µA
Resolution	15 µA
Input Impedance	10 KΩ
LED	Yes

Binary Inputs

Type	AC + DC analog voltage inputs
Number	8
Nominal Input Ranges	0 ... 4.5 V / 0 ... 30 V / 0 ... 188 V
Amplitude Accuracy	1 mV / 3 mV / 10 mV
Sampling Frequency	5 KHz
Transient Input Buffer	Infinitive
Input Impedance	150 KΩ // 100 pf
Measurement Functions	V(AC,DC) , phase , transient
Input Overload Indication	Yes
Input Protection	Yes
Max. Input Voltage	300 VPK
Galvanic Isolation	8 Group (1+1+1+1+1+1+1+1)
LED	Yes

Relay Tester AMT105



Voltage Generators

4 Phase (L-N)	AC: 4 X 0 ... 150 V(60 VA at 150 V)
	DC: 4 X 0 ... 210 V(84 W at 210 V)
1 Phase (L-N)	AC: 1 X 0 ... 150 V(120 VA at 150 V)
	DC: 1 X 0 ... 210 V(168 W at 210 V)
1 Phase (L-L)	AC: 1 X 0 ... 300 V(120 VA at 300 V)
	DC: 1 X 0 ... 420 V(168 W at 420 V)
1 Phase (L-L-L)	AC: 1 X 0 ... 450 V(200 VA at 450 V)
	DC: 1 X 0 ... 630 V(250 W at 630 V)

Power & Range Setting

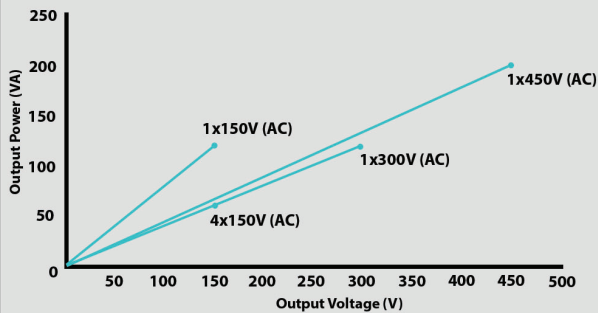

Phase Resolution / Accuracy 0.001 / 0.1 from 0 to 360

Resolution / Accuracy 10 mV / 0.2% or 100 mV at full load

Frequency Resolution / Accuracy 1 mHz / 1 mHz from 0 to 1500 Hz

Max. Compliance Voltage 212 VPK

Connection Banana Sockets 4 mm (0.16 in) banana sockets / combination socket (1,2,3,N)

Short Circuit / Overcurrent Protection Yes

LED Yes

Current Generators

6 Phase (L-N)	AC: 6 X 0 ... 32 A(100 VA at 32 A)
	DC: 6 X 0 ... 32 A(140 W at ± 32 A)
3 Phase (L-N)	AC: 3 X 0 ... 64 A(200 VA at 64 A)
	DC: 3 X 0 ... 64 A(260 W at ± 64 A)
1 Phase (L-N)	AC: 1 X 0 ... 128 A(400 VA at 128 A)
	DC: 1 X 0 ... 128 A(540 W at ± 128 A)
1 Phase (L-N)	AC: 1 X 0 ... 32 A(400 VA at 32 A)
	DC: 1 X 0 ... 32 A(540 W at ± 32 A)

Power & Range Setting

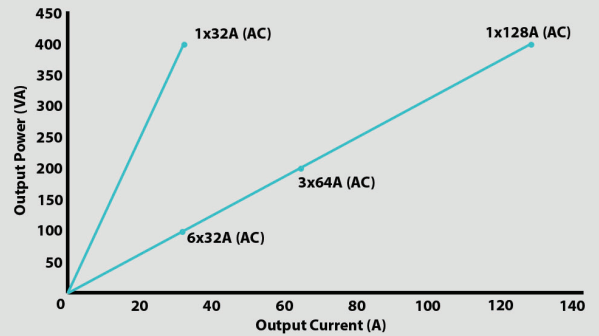

Phase Resolution / Accuracy 0.001° / 0.1° from 0° to 360°

Resolution / Accuracy 1 mA / 0.2% or 2 mA at full load

Frequency Resolution / Accuracy 1 mHz / 1 mHz from 0 to 1500 Hz

Max. Compliance Voltage 12 VPK

Connection Banana Sockets 4 mm (0.16 in) banana sockets / 32 A continuously

Connection Combination Socket Group A/B(15 A continuously max)

Overcurrent Protection Yes

LED Yes

Maximum Neutral Current 32 Amp

Relay Tester AMT105



Brief List of Specifications

Different Testing Rooms

Home Page of Vebko Software

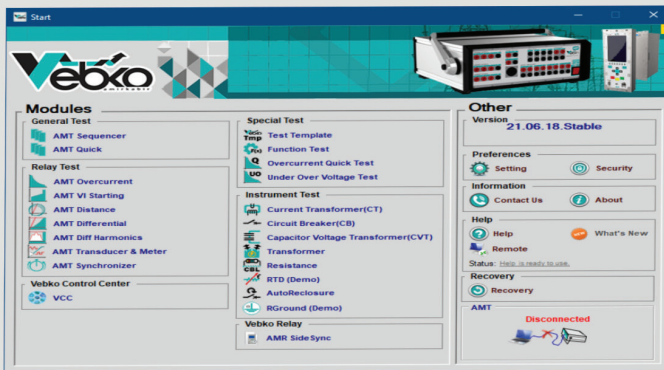

AMT Sequencer

Used to design tests that employ the normal, Quick Step Ramp, Continuous Ramp, Harmonic, Transient

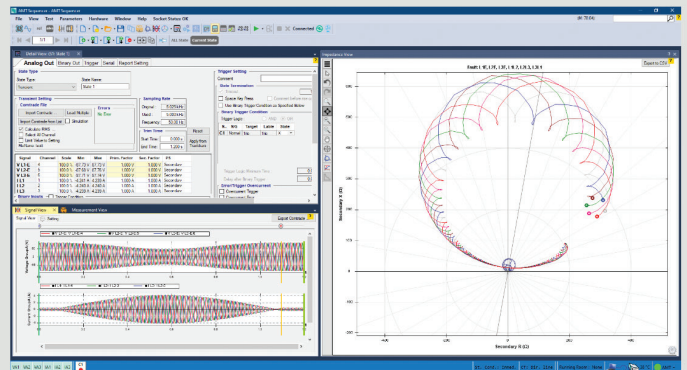

AMT Overcurrent

Used to test current functions like 51/50/67 etc.

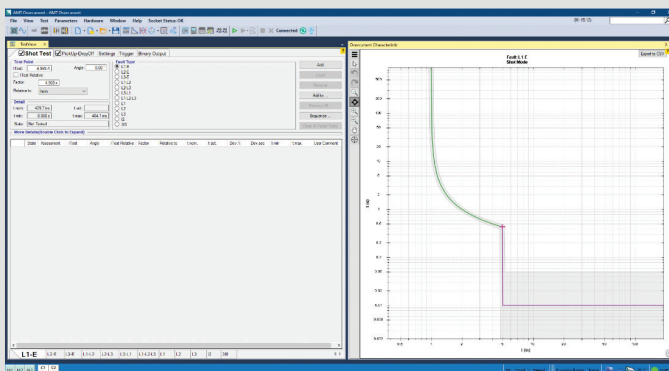

AMT Distance

Used to test Impedance functions

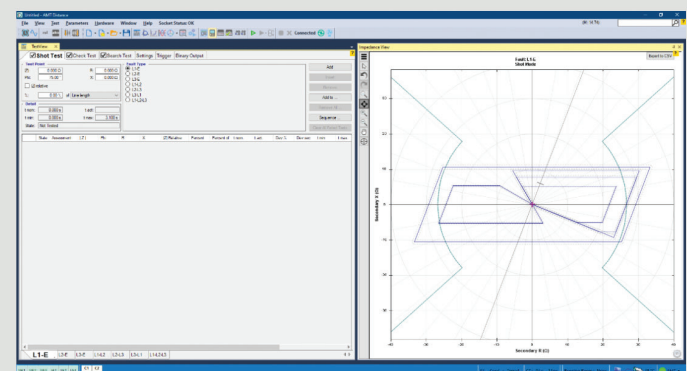

AMT Differential

Used to test differential function

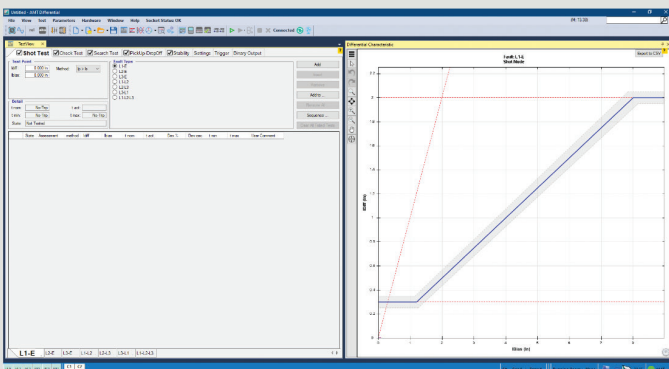

Transducer & Meter

Used to test Transducer & Meter.

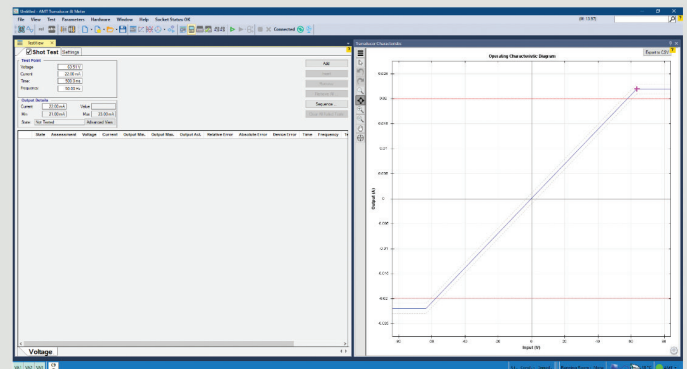

Relay Tester AMT105



AMT Synchronizer

Used to test synchronizer relay

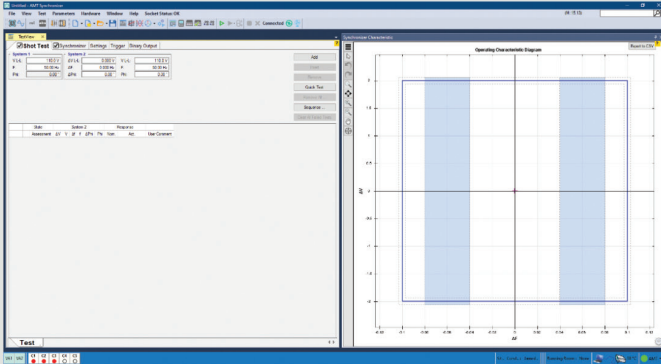

VCC

Used to successively run the tests designed for a relay

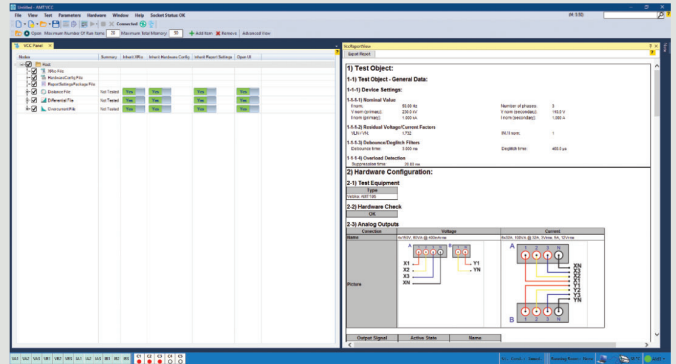

Current Transformer

Used to test various classes of CT.

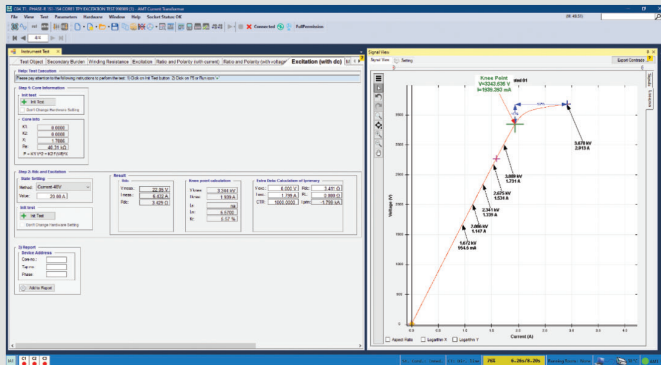

Circuit Breaker

Used to MV & HV circuit breaker tests.

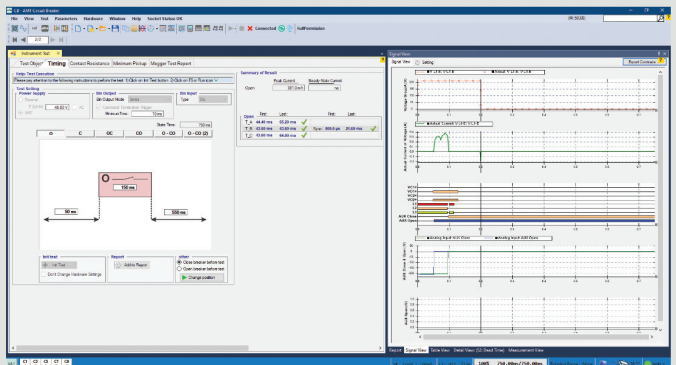

CVT

Used to test various classes of CVT

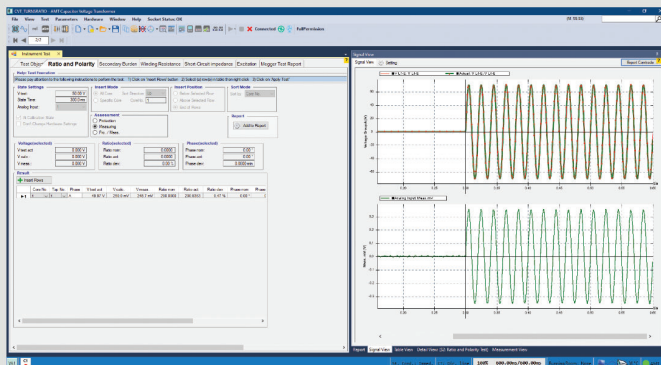

Transformer

Used to perform different transformer tests

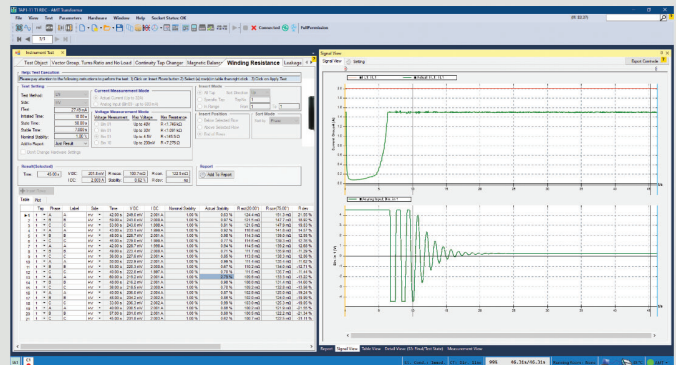











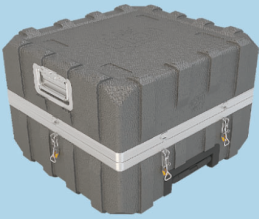
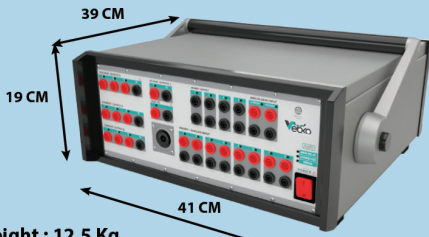
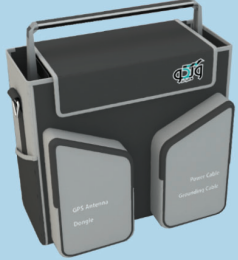







Relay Tester AMT105

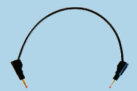

Vendor List

Line	Company names	National ID	Field	Domestic / Foreign	Nationality	Specifications	Product Category	Province	City	Address	Phone	Fax	Update Date	Description
656	Vebko Amirkabir remonitoring power quality	14004384990	Manufacture	Domestic	Iran	Relay protection tester AMT & Multifunction protection relay AMR	67	Qazvin	Qazvin	5th Floor, Building No 76, Parastar Boulevard, Norouzian Boulevard	+982833692361	+982833632038	2017/11/05	Self Declared

Equipment in Transportation Case

	 39 CM 19 CM 41 CM Weight : 12.5 Kg Ethernet 10/100/1000 base		
Tester Transportation Case	AMT 105 Relay Tester	Shoulder Bag	Transformer Test Cable
AMT1001 Qty: 1	AMT1002 1	AMT1003 1	AMT1004 3
			
Transformer Test Clamp	Load Cable	Combination Cable	Ethernet Cable
AMT1005 8	AMT1006 5	AMT1007 1	AMT1008 1
			
Capacitor Box	Power Cable	Crocodile Clips to Contacting Pins or Screw Bolts	Cable ties (Velcro fastener) Black , 150 mm long
AMT1014 Qty: 1	AMT1011 4	AMT1012 4	AMT1013 5
			
Serial Dongle	Flexible test load adaptive with retractable sleeves 4 mm safety plugs 30 cm long , 32 A	Jumper, Flexible, 6 cm Long for paralleling current triple A and B	Cable ties (Velcro fastener) Black , 150 mm long
AMT1020 1	AMT1015 12	AMT1016 12	AMT1017 1
			
Flexible terminal adapters 2.5 cm , 4 mm , 32 A	Cable Lug Adapter 4 mm	Ground Cable	Optical sensor for testing meter
AMT1018 1	AMT1019 1		
			

Relay Tester AMT105



List of Clients

Co. Name	Qty	Co. Name	Qty
Specialized Holding	4	Shirvan Combined Cycle Power Plant	1
Tavanir	3	Parand Combined Cycle Power Plant	1
Iran Grid Management	1	Shahid Kaveh Combined Cycle Power Plant	1
Consulting	4	Sardasht Hydropower Plant	1
Hoodad Niroom Pars	1	Montazer Ghaem Power Plant	1
Moshanir	1	Kashan Combined Cycle Power Plant	1
Monanco	1	Khorramshahr Combined Cycle Power Plant	1
Noavaran Arman Pouya	1	Roodshour Power Plant	1
Regional Electric	19	Dez Dam and Power Plant Production and Operation	1
Khorasan Regional Electricity	6	Regional electrical company for repairs	133
Fars Regional Electricity	1	Azərbaycan Elctrical Power Maintenance	3
Azerbaijan Regional Electricity	2	Khuzestan Power Transmission Maintenance (TANANIR)	10
Kerman Regional Electric	1	Bootia Niroom	9
Bakhtar Regional Electric	1	Akhtar Bargh	13
Semnan Regional Electric	2	Gilan Land Electrical Engineers	3
Hormozgan Regional Electric	1	Tanesh	6
Zanjan Regional Electric	1	Peyman West	11
Mazandaran Regional Electric	1	Tehran Power Transmission Maintenance Engineering (METANIR)	22
Gilan Regional Electric	1	Fars Power Maintenance	11
Yazd Regional Electric	1	Arman Niroom Hormozgan	4
Isfahan Regional Electric	1	Niroom Faraz Jonub Shargh	5
Power Plant	30	Azarakhsh Transmission Power	5
Chabahar Combined Cycle Power Plant	1	Bakhtar Production and Transmssion of Electricity (Betanir)	17
Zahedan Power Generation	1	Oil Contractor	10
Mohammad Montazeri Power Generation Management	1	Jahanpars Co	1
Isfahan Power Generation Management	1	EXIR SANAT	1
Mashhad Power Generation Management	1	Aghajari Oil and Gas Exploitation	1
Besat Power Generation Management	1	Petro Sanaat Jonoob	1
Neka Power Generation Management	1	OICO Company	1
Kish Water & Power	1	Talash Gostar Energy Development Management	1
Shahid Rajaee Power Generation Management	1	Mapna Neyr Perse	1
Soltanieh Combined Cycle Power Plant	1	Maroon Oil & Gas	1
Touss Power Generation Management Company	1	Arvandan Oil and Gas	1
Powerhouse of the Dahlato Combined Cycle	1	Terminals and Tanks Petrochemical	1
Bisotun Power Generation Management	1	Petrochemical	29
Loshan Power Generation Management	1	Hengam Petrochemical	1
Shahid Mofateh Power Generation	1	Kangan Petro Refining	1
Kowsar Zagros Power Plant Production & Management	1	Marjan Petrochemical	1
Bandar Abbas Power Generation	1	Jam Petrochemical	1
Qom Combined Cycle Power Plant	1	Razi Petrochemical Company	1
Aliabad Golestan Power Plant	1	Maroon Petrochemical	1
		Shiraz Petrochemical	1
		Lorestan Petrochemical	1

Co. Name	Qty	Co. Name	Qty
Fajr Petrochemical	2	Hana Energy Iranian Company	1
Fresa Chemistry	1	Mohandesin Bakhtar Moshaver	1
Bushehr Petrochemical	1	Nojan Niroom Novin Iranian	1
Mahabad Petrochemical	1	Asa Electrical Engineering	1
Nouri Petrochemical	1	Atrak Sazeh Pars Gostar	1
Damavand Petrochemical	1	Niroom Pardaz Energy Co	1
Isfahan Petrochemical	1	Altair Systems	1
Bakhtar Petrochemical	1	Amin Niroom Aria Koosha Engineering (Manaco)	1
Pars Petrochemical	2	Andia Solar Industry	1
Arvand Petrochemical	1	CV Kiat Energi (IDN)	1
Shazand Petrochemical	1	Públio Bernardes Severino(BRA)	2
Polypropylene Jam	1	Mr.Made Arimbawa	2
Kermanshah Polymer	1	Power Substation Contractor	68
Kavian Petrochemical	1	Sanat Niroom Arka	1
Masjed Soleyman Petrochemical Industries Co	1	Nikan Andisheh Bootiya	1
Polynar Corporation	1	China Gzuba Group Limited CGC	1
Kimia Pars Middle East Petrochemical	1	Behin Electric Is A New Phenomenon	1
Petro Kimia Ibn Sina	1	Iran Transfo Post Development	1
Imam-Bandar Water Petrochemical Co.	1	Kian Sanat Nikan Isatis	1
Engineering	50	Power Team	1
Zarrin Samane Shargh	1	Iranian Power Energy Innovators (IRN)	1
Talash Sanat Dirin Daghigh	1	Niroom Sanat Iranian	1
Fanavaran Energy Toos Co	5	Niroom Bam Pars	1
Sintaksa (HRV)	1	Pars Voltajhe Dashtestan	1
Ideh Tajhiz Control Trading Engineering	1	Mabna Niroom	1
Advensys	1	Hemmat Karan Engineering Technical	1
Kia Electronic Faraz Co	2	Peyman Niroom	1
Pishtaz Tamin Tajhiz Garb Company	1	Arya Petronir Novin	1
Mashhad Tadbir	1	Nasr Niroom Yazd Company	3
Tavan Tajhiz Azma	1	COMPANY SSCO	1
Gostaresh Energy Matin Asia	1	Pars Sayna Energy	1
Safa Nicu Sepahan	1	The Eastern Shore Force Protection	1
Erika Sanat Varna	1	Mohammad Hadad (SWE)	1
Hefaz Sanat Arya	1	Shahab Niroom (AFG)	2
Yam Electric installation and Contracting Company	1	Moham Shargh Group	1
Tavanmand Consulting Engineering	1	Power Technology Pyramids (PTP)	1
Nogaran Ghodrat Engineering Services	1	Parsian Group	2
Orumieh Sanjesh Sehat	2	Mr. Khalilinia (IRQ)	1
Arianir Engineering	3	Ertebat Andishan Sanaat Sefahan	1
Nivand Energy Pooya	1	Peyman Khotoot Shargh	1
Behbood Sanat Niroom Consulting Engineers	1	South Pimaneh Energy	1
Power Grid Solution (AUS)	1	Pars Power	2
Parto Parsian Energy	1	Niru Danesh Espadana	1
Kavosh Niroom Gostar Pazh Company	2	Tabdil Niroom Aria	1
		Roshan Gostar Toos	1
		Karmania Voltage	1

Relay Tester AMT105



List of Clients

Co. Name	Qty	Co. Name	Qty
Faraniroo Engineering company	3	Persian Gulf University	2
Kiyan Isatis Pars	1	Province Electricity Distribution	28
Raysanat Sasan	1	Ardabil Electric Power Distribution	1
Matin Nirou Zagros	1	Southern Kerman Electricity Distribution	1
Raysanat Sasan	1	North Kerman Electricity Distribution	1
Kava Tavan Zagros	1	Sistan & Baluchestan Electric Power Distribution	1
Petro Pars Ghodrat	1	Hormozgan Province Electric Power Distribution	1
Niroo Azma Payam	1	Yazd Electricity Distribution	1
Ray Avin Fav	2	Khuzestan Province Electric Power Distribution	1
Parseh Niroo Caspian	1	Semnan Distribution	1
Intis (HRV)	1	Shiraz Electricity Distribution	1
Bonyan Niroo Kerman	1	Great Tehran Electricity Distribution	2
Control Ghodrat Pars Co	2	Alborz Electric Power Distribution	1
Ariya Ghodrat kavir	2	Tehran Province Electric Power Distribution	4
Pooya Niroo Spadana Co	1	Isfahan Province Electric Power Distribution	1
Tarh & Tose'eh Peyman Zagros	2	Qom Province Electric Power Distribution	2
Saeghe Niroo Yazd Co	1	East Azarbaijan Province Electric Power Distribution	2
University	28	West Azarbaijan Province Electric Power Distribution	1
Semnan University	1	South Khorasan Province Electric Power Distribution	1
Amirkabir University Of Technology	2	Razavi Khorasan Province Electric Power Distribution	1
Yazd University	1	North Khorasan Province Electric Power Distribution	1
Faculty Of Electrical and Computer Engineering - Tabriz University	1	Kermanshah Province Electric Power Distribution	2
Esfahan University Of Technology	1	Fars Province Electric Power Distribution	1
University Of Isfahan	1	Steel	31
Ministry Of Science & Technology Research & Technology University Of Birjand	1	Sabzevar Steel Pars	1
Damghan University	1	International Technical Steel Engineering	1
Sharif University Of Technology	2	Golgohar Mining & Industrial	1
Sistan University	1	Sangan Iron Ore Complex	1
Ministry Of Science and Research Of Tehran University	2	Sepehr Sharq Steel Company	1
Khaje Nasir al-Din Tusi University Of Technology	1	KHAYYAM STEEL NEYSHABOUR	1
Shahid Bahonar University Of Kerman	1	Chahar Mahal Bakhtiari Car Paper	1
Shahid Beheshti University	2	Khuzestan Oxin Steel Co	1
The Graduate University Of Advanced Technology	1	Khuzestan Steel Company	1
University Of Lorestan	1	Bonab Steel Industry Complex	1
Shahrood University	2		
Ministry Of Science Research & Technology Of Shahid Chamran University Of Ahvaz	1		
Mazandaran University Of Science And Technology	1		
Ministry Of Science Research & Technology University Of Science And Technology	1		
Babol Noshirvani University Of Technology Faculty Of Electrical & Computer Engineering	1		

Co. Name	Qty	Co. Name	Qty
Foolad Gharb Asia Co	1	Gas	5
Arfa Iron And Steel	1	Fateh Sanat Kimia	1
Pasargad Steel	1	Region 2 of Isfahan Gas Transmission Operations	1
Zarand Iranian Steel	1	District 3 of Tehran Gas Transmission Operations	1
Mobarakeh Steel	1	Gas Transmission Operation Zone 8	1
Sirjan Iranian Steel	2	Gas Transmission Operation Zone 6	1
Saba Steel	1	Aluminum Industry	3
South Kaveh Steel Kish	1	Iran Aluminum (Iralco)	1
Jahan Ara Arvand Steel Factory	2	Almahdi Aluminium Co	1
Chadormalu Steel Company	1	IRAN ALUMINA Co	1
South Rouhina Steel Complex	1	Producers of electical panels	13
Sefid Dasht Steel Complex	1	Taban Tablou East	1
Golgohar Iron & Steel Development Co	3	Fanavaran Sane Shargh Co	2
Copper Industry	3	Ranin Sanat Gostar Company	2
Shahrbabak Copper Complex	1	Supply Board	1
Shahid Bahonar Copper Industries	1	Electro Kavir	1
Fulmen	1	Ista Noavaran Niro company	1
Relay Maker	11	Noavaran Bargh Aria	1
Atrak Energy Gostar Aras CO	1	Fajr Tablo Co	1
Arma Pooyesh Analysts	1	Arian Key Pars	1
Mehvar Azma	4	Subsidiaries	2
Hemianfen	4	Subsidiary	2
Persian Processing Energy Power	1	Real Person	49
Trading	3	Mr. Mohsen Kaviani Baghbadarani	1
Turkuaz Group (TUR)	1	Mr. Rahimi	2
IRANA SYSTEM COMPANY	1	Mr. Aslani	2
Danesh Energy Sarir Co	1	Mr. Sadeghi	1
Oil Refinery	18	Mr. Ghasabian	1
Tabriz Oil Refining	1	Mr. Gholamian	1
Shahid Hasheminejad Gas Refining (Khangiran Refinery)	1	Mr. Jafari	3
Abadan Oil Refining	2	Mr. Salar Farshid	1
Shazand Imam Khomeini Oil Refining	1	Mr. Roshani	1
Shiraz Oil Refining	1	Mr. Arjmand	1
South Pars Gas Complex Second Refinery (Phases 2 and 3)	1	Mr. Shamshiri	1
South Pars Gas Complex Fourth	1	Mr. Alipoor	2
South Pars Gas Complex Sixth Refinery (Phases 15 & 16)	1	Mr. Kasiri	1
South Pars Complex 9th Refinery Phases (12)	2	Mr. Sahrayian	1
Isfahan Oil Refining	2	Mr. Solymanpour	1
South Pars Gas Complex (Phase 5)	1	Mr. Sabzalian	1
Bidboland Gas Refinery Persian Gulf	1	Mr. Hassan Dehghan	1
South Pars Gas Complex 10th refinery	1	Mr. Estaki	1
Behran Oil Co	1	Mr. Jamaliyan	1
Gachsaran Oil And Gas Exploitation	1	Mr. Gohardani	1
		Mr. Zafarani	1
		Mr. Paweł Wicher (POL)	1
		Mr. Molaei	1
		Mr. Nasr	1
		Mr. Mirmohammadi	1
		Mr. Masoud Karimi	1
		Mr. Farhadi	1

Relay Tester AMT105

List of Clients

Co. Name	Qty	Co. Name	Qty
Mr. Malekshahi	1	Utility	3
Mr. Yahoo	1	Industrial Lines Development	1
Mr. Ahmadi	1	MAPNA Railways Development	1
Mr. Shah Mohammadi	1	National Iranian Oil	1
Eng. Najafi Hajivar	1	Transformer	3
Eng. Gholam Qous Marvi	1	Alvand Tavan Energy	1
Eng. Cheraghpour	1	Niroo Trans Sepahan	1
Eng. Soleimani	1	Ebda Sanat Bargh Co	1
Eng. Reza Jiani	1	Agency	9
TebNox projects and consultants Lty Ltd(ZAF)	1	GenEko j.d.o.o. (HRV)	7
Eng. Cheraghpour	1	Moises Goncalves (CAN)	1
Eng. Soleimani	1	ADEODUN SOJI TAYO	1
Eng Tech MIET (GBR)	1	Organizations	1
Eng. Ghasemi	1	Power Research Institute	1
Motaz Al-Fayomi	1	Power plant services	12
Eng. Faghani	1	Alborz Turbine Power Plant Engineering and Support	2
Eng. Saeed Rafiei	1		

Co. Name	Qty	Co. Name	Qty
Khuzestan Hydropower Plant Installation Repair & Maintenance	1	Engineering, procurement and construction	3
Iran Power Plant Repairs	2	Shoa Gostar Shargh Co	1
Ahar Power plant services	1	Energy Sazan Takin Co	1
MAPNA Operation and Reconstruction	2	OIEC Group	1
Atomic Energy Engineering and Manufacturing	1	Sea Ports And Shipping	2
Pasargad Energy Development	2	Iran Marine Industrial (Sadra)	1
Niroo Sanat Sarcheshmeh	1	Port & Maritime Organization of Khuzestan province- Imam Khomeini seaport	1
Mining Industry	2	Water and Wastewater	1
Sang Gohar Zamin Sirjan	1	Tehran Water and Wastewater Treatment	1
Sepahan Revival Iron Ore Mines	1	Engineering, procurement and construction	2
Industrial automation	2	Ahvaz Power Distribution company	1
MECO	1	Isfahan Distribution	1
Iran Supply and Control Systems	1	Vebko	5

Contact Information

Head Office 1

Unit 15, 4th floor, No 2, Bujarisefat alley, Fariman junction, Bozorgmehr St. Valiasr Sq, Valiasr junction, Tehran, Iran
Phone : +982164545736
Fax : +982143852513
Email : info@vebko.org

Head Office 2

Amirkabir polytechnic university center for growth & entrepreneurship Unit 12, 1st floor, No 7, Balavar St. Across from daneshjoo park, Valiasr Junction, Tehran, Iran

Technical Office

5th floor, No 76, Parastar Blvd, Qazvin, Iran
Dr. Farzad Razavi
+989121773241
Postal code : 3414689168

Sales Office

5th floor, No 76, Parastar Blvd, Qazvin, Iran
Postal code : 3414689168
Phone & Fax : +982833690245
Sales Department : +989193849604
Email : sales@vebko.org

International Office

Unit 8, 3th floor, No 23, 45 meter kaj Blvd , Azimiyeh , Karaj , Alborz , IRAN
Phone : +989124335547
Email : Mostafa.Hajati@vebko.org

Chief Executive Officer

Dr. Farzad Razavi Tell : +989121773241

Senior Expert

Dr. Ali Akbar Nazari Tell : +989127833092
Mr. Abolfazl Tayefeh Tell : +989021804584

Telegram & LinkedIn

<http://t.me/vebko> , @vebkobot
Telegram Channel : @vebko
Linkedin : VebkoAmirkabir
Youtube : Vebko

Website

www.vebko.org

International-Technical Marketing Director

Mr. Mostafa Hajati Tell : +989124335547



Vebko Co.

www.vebko.org